

Materials Performance in USC Steam FY10.MSE.1610222.682

Gordon R. Holcomb, Ping Wang, Paul D. Jablonski, and
Jeffrey A. Hawk

Outline

Introduction

- Ultra Supercritical Steam Turbines
- Research Aims and Project Information

Results

- Casting and Homogenization
- Oxidation Behavior

Summary

Impact of Advanced Coal Generation on CO₂ Emissions

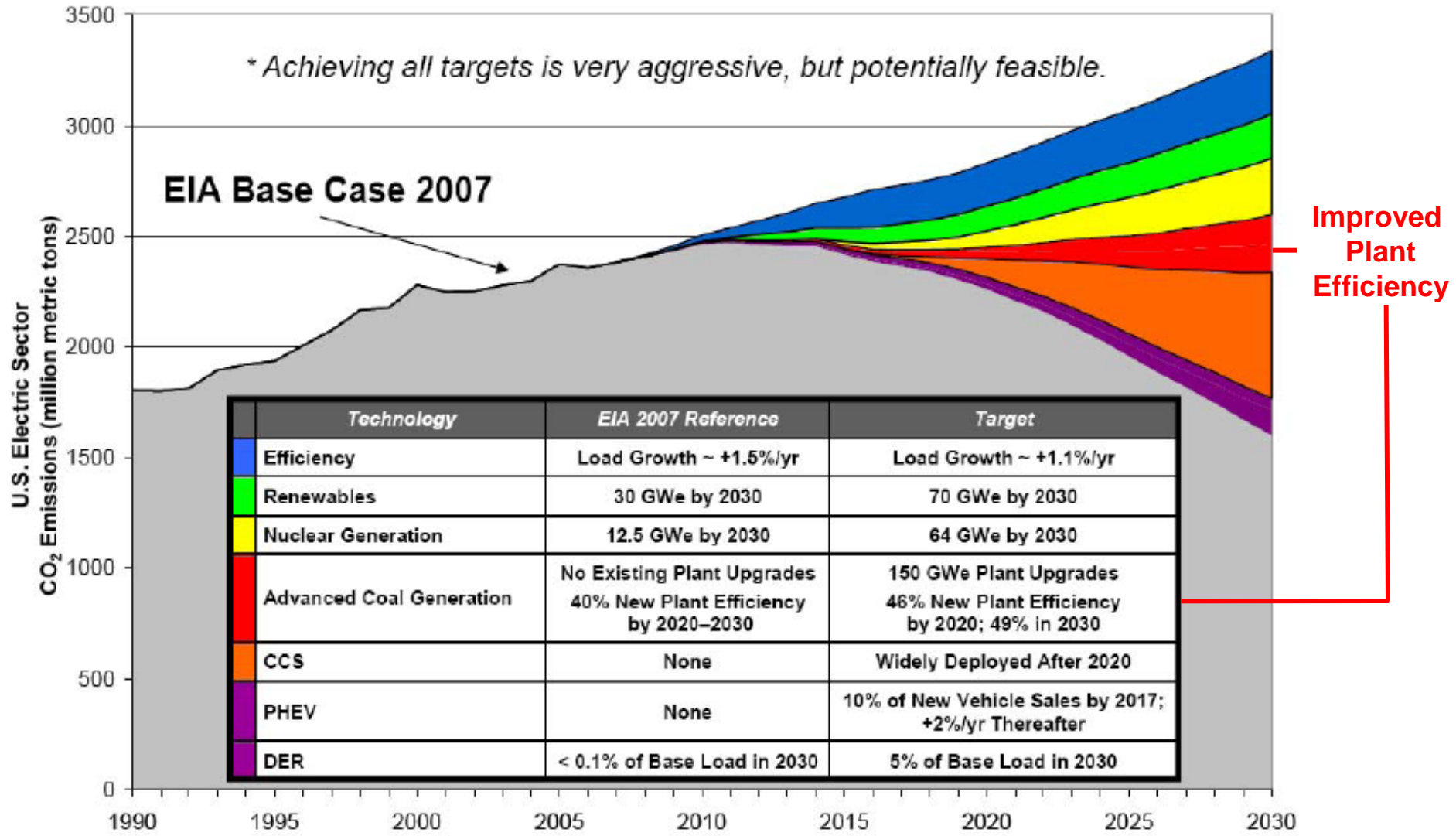

Increasing Efficiency

Each 1% increase in efficiency eliminates ~1,000,000 tons of CO₂ emissions over the lifetime of an 800-MW plant

US-DOE Advanced Power Systems:
46%-48% efficiency from coal generation
Steam condition: 760 C - 35MPa
~ 5ksi

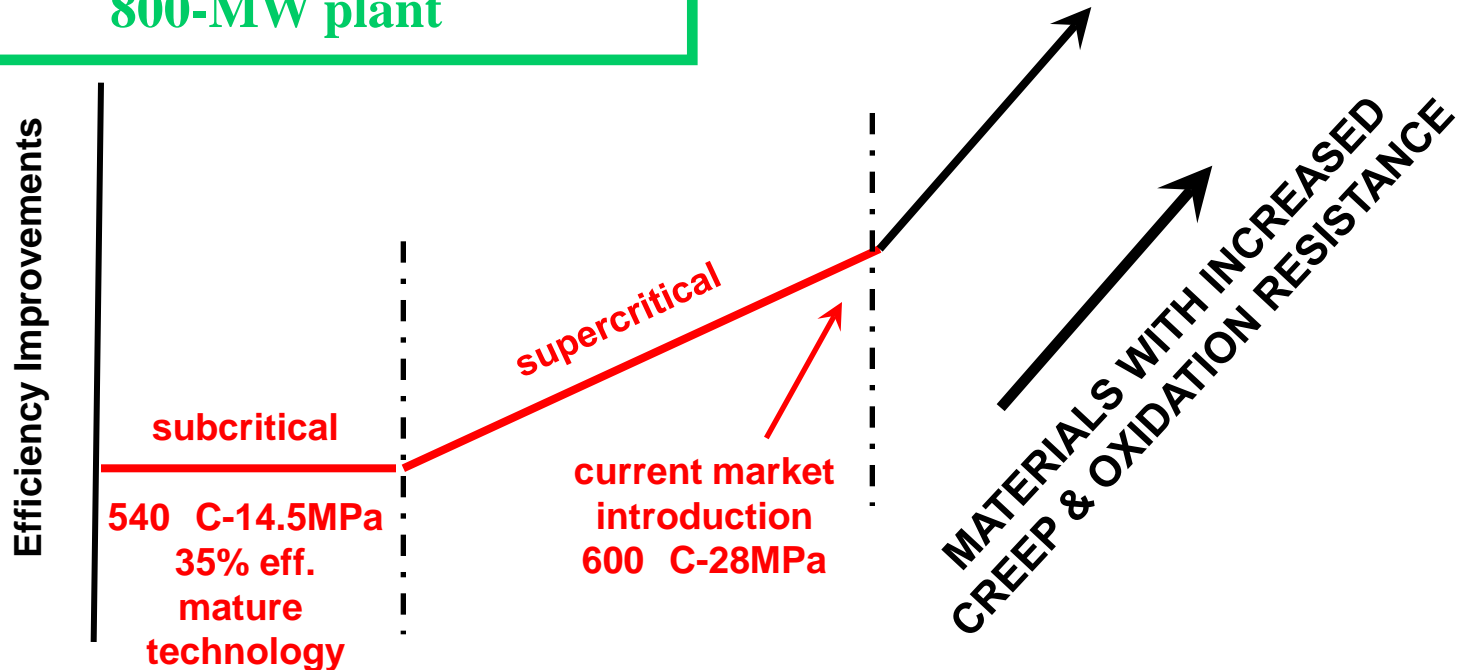

Subcritical: < 22 MPa

Supercritical (SC): > 22.1 MPa, 538 to 565 C

Ultra Supercritical (USC): 565 to ~675 °C (advanced ferritic & austenitic steels required)

Advanced Ultra Supercritical (A-USC): > ~675 °C (nickel-base superalloys required)

Technological Issues

Higher T&P place greater demands upon Materials

- **Large castings are required for some components—many technical issues**
- **Pressure effects not entirely understood**
- **Earlier research on chromia evaporation showed that it may be of concern in HP turbine**

FY'10 Project goals are to understand steam oxidation for these three issues

2010 Milestones 1 & 2

Complete 2000 hr exposures of cast and wrought A-USC alloys in steam, 3/31/2010

- Modified research plan from 7 to 3 alloys to focus on successful alloys
- Complete

Identify effects from casting and homogenization procedures on the oxidation behavior of cast A-USC alloys, 6/30/2010

- Ongoing
- **The basis of most of the presentation**

2010 Milestones 3 & 4

Complete installation and shakedown of autoclave, 9/30/2010

- Mechanical installation complete
- Control system out on bid
- Dual rated 1 liter autoclave
 - 4500 psi at 1400°F (310 bar at 760°C)
 - 5000 psi at 1375°F (345 bar at 746°C)

Refine/validate chromia evaporation model based on oxidation kinetics at high gas velocities and surface analyses of chromia-depleted scales, 9/30/2010

- Samples being designed and machined
- Will allow tests at up to 40 m/s in moist air

2009 Milestones

Obtain cost estimates for autoclave design. Decide to go forward or not with design development

- Completed, elected to go forward with design and procurement

Compete sample preparation on cast (NETL produced) and forged versions of candidate nickel-base superalloys

- Completed (and used in 2010 tasks)

Complete cyclic oxidation tests on cast and forged versions of candidate nickel-base superalloys

- Elected to do exposures in steam environments instead of cyclic tests in moist air (became a 2010 task)

Update chromia evaporation model based improved understanding of the underlying processes

- Complete. Updated model for:
- Improved thermodynamics of $\text{Cr}_2(\text{OH})_2(\text{g})$ from Opila (NASA)
- Partial saturation of $\text{Cr}_2(\text{OH})_2(\text{g})$ in the gas phase
- Translated evaporation rate into alloy lifetime prediction

Large Castings for A-USC Components

Casting Challenges

- 1-15 tons
- Up to 100 mm in thickness
- Slow cooling rates
- Segregation prone alloys

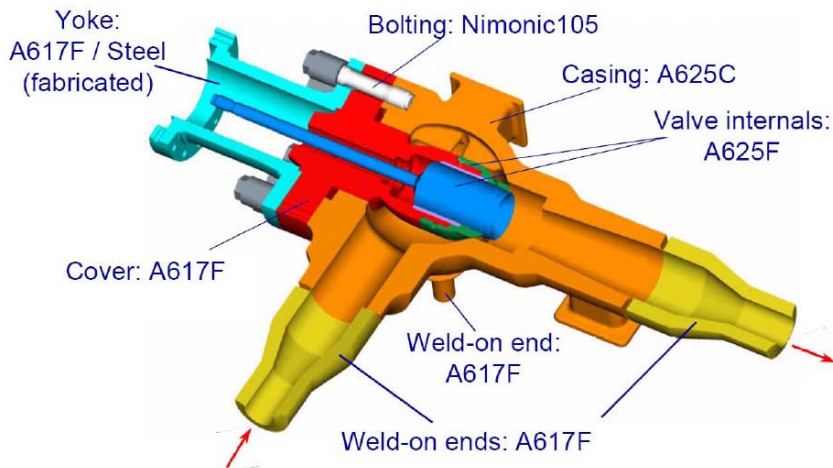

Valve Bodies

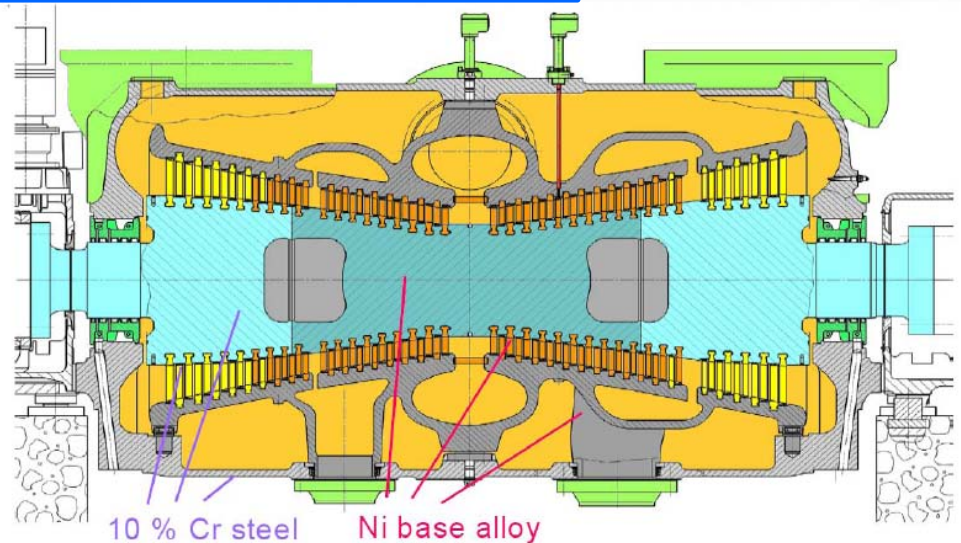

Turbine Casing

Cast Materials for A-USC Steam Turbines

Examined a suite of traditionally wrought Ni-based superalloys cast under conditions designed to emulate the full sized casting

- Traditionally wrought alloys are being considered due to proven weldability in thick sections—Input from USC Consortium
- A computationally optimized homogenization heat treatment was developed to improve the performance of these materials—Paul Jablonski

Steam oxidation resistance

- Compare the steam oxidation behavior of cast versions of candidate Ni-based superalloys with their wrought counterparts

Ingot Chemistries

	C	Cr	Mo	Co	Al	Ti	Nb	Mn	Si	B	W
N105	0.15	14.85	5.00	20.00	4.70	1.10		0.50	0.50	0.05	
	0.16	14.61	5.02	20.04	4.43	1.10		0.51	0.51	0.05	
H230	0.120	22.00	2.00		0.35			0.70	0.50		14.00
	0.12	21.59	2.01		0.37			0.69	0.50		13.91
H263	0.070	20.00	5.80	20.00	0.35	2.10		0.50	0.35		
	0.07	19.68	5.74	19.89	0.40	2.04		0.50	0.34		
H282	0.070	19.50	8.50	10.00	1.50	2.10		0.25	0.15	0.005	
	0.07	19.22	8.48	9.84	1.44	2.08		0.24	0.15	0.01	
IN617	0.120	22.00	9.00	12.50	1.10	0.30		0.50	0.50		
	0.12	21.73	8.96	12.35	1.04	0.31		0.50	0.49		
IN625	0.070	21.00	9.00		0.10	0.10	3.60	0.50	0.35		
	0.07	20.71	8.92		0.15	0.089	3.58	0.49	0.34		
IN740	0.030	25.00	0.50	20.00	1.30	1.50	1.50	0.30	0.30	Fe:	0.70
	0.04	24.71	0.50	20.03	1.24	1.48	1.50	0.30	0.31		0.57

Aims

Results

N105—Solidification

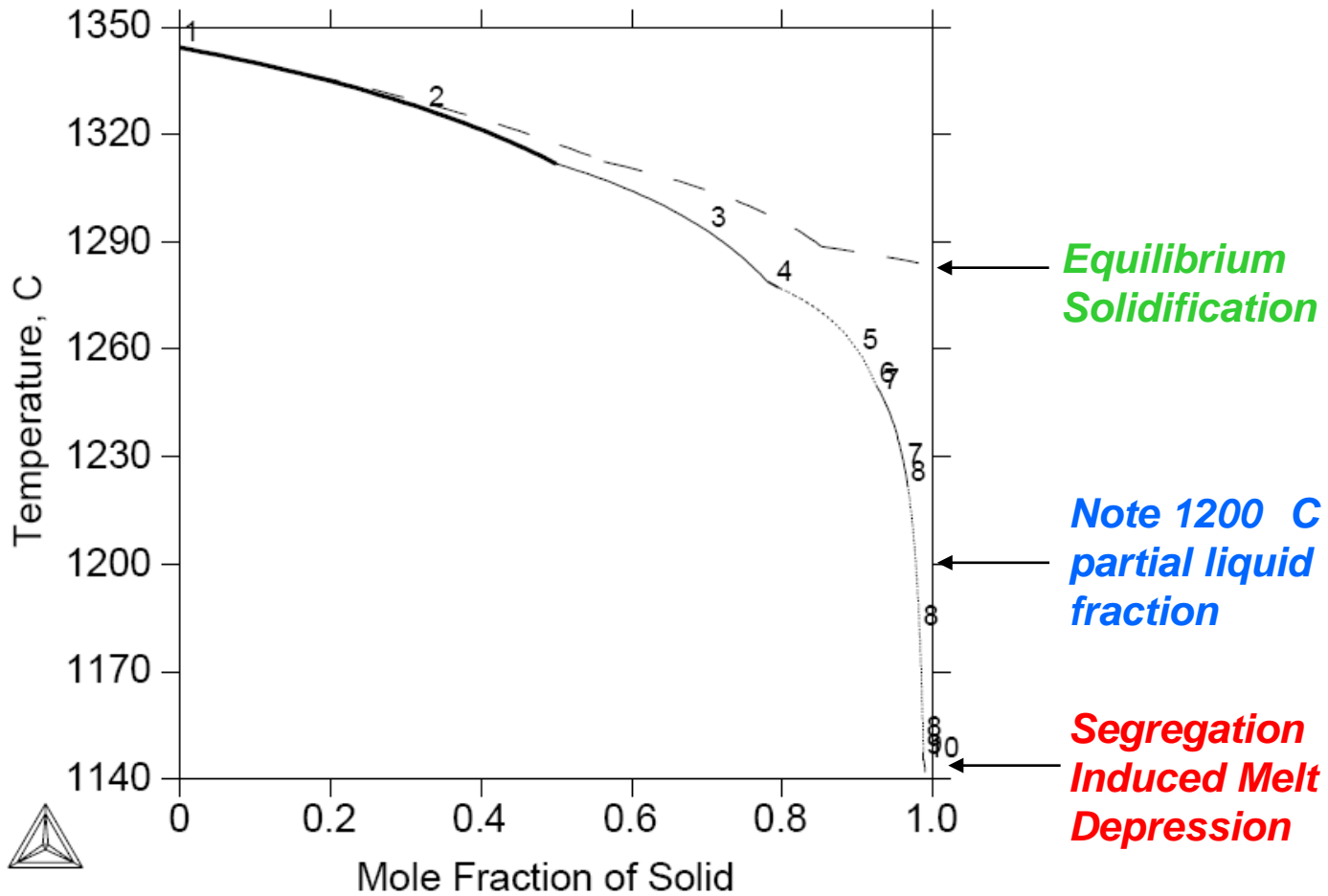

N105—Homogenization Heat Treatment Comparison

1 2 3 4

TIME = 0, 10000, 40000, 80000

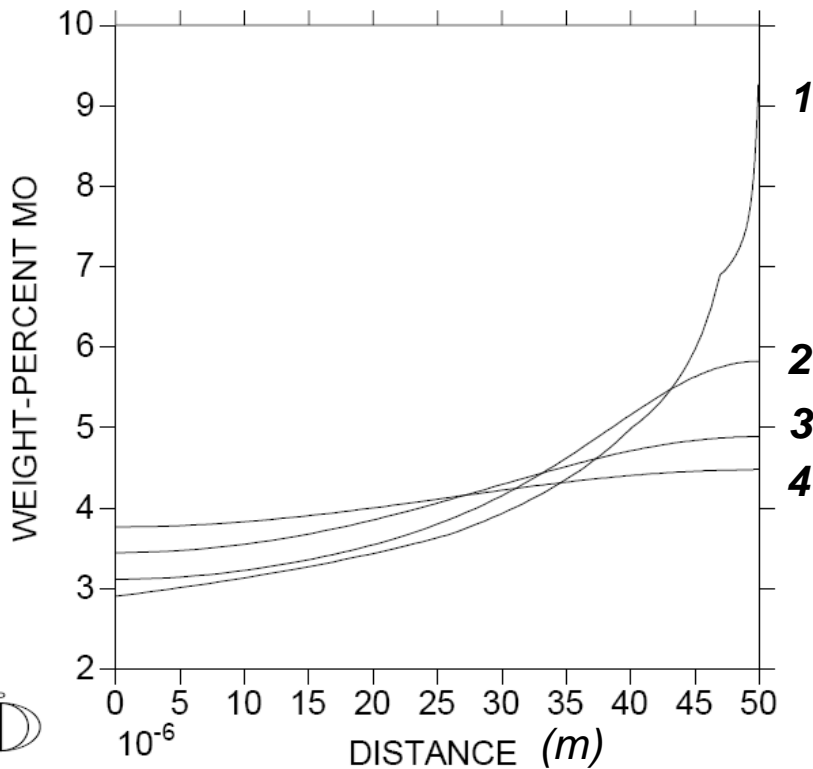

Isothermal at 1100 C

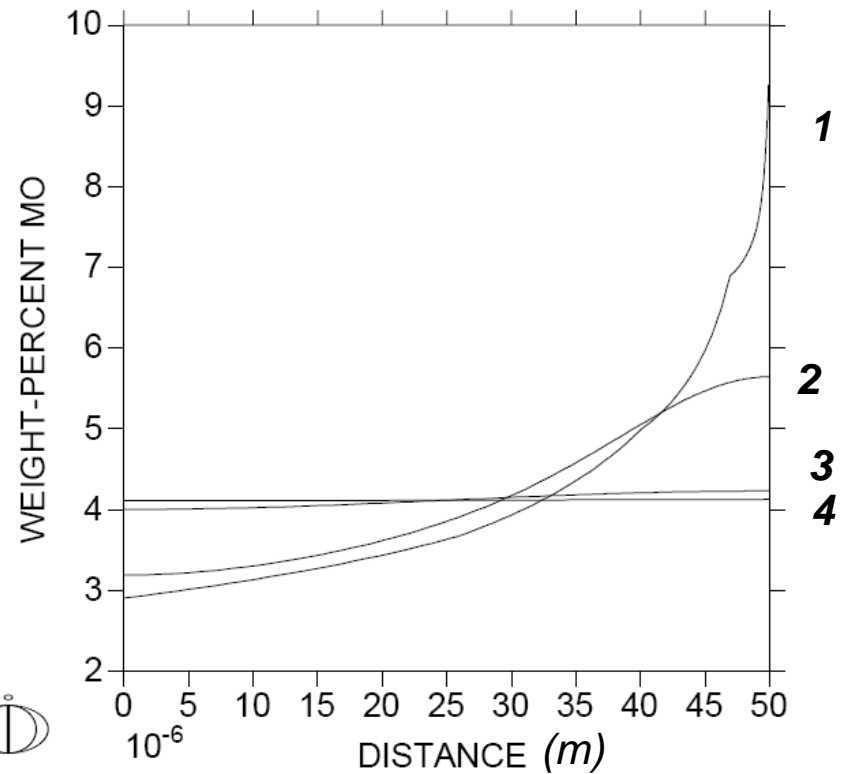

1100 C/10,000s+1200 C/remaining time

Patent Pending

Metall. Trans. B, 40B, (2009) 182.

800 C Creep Results

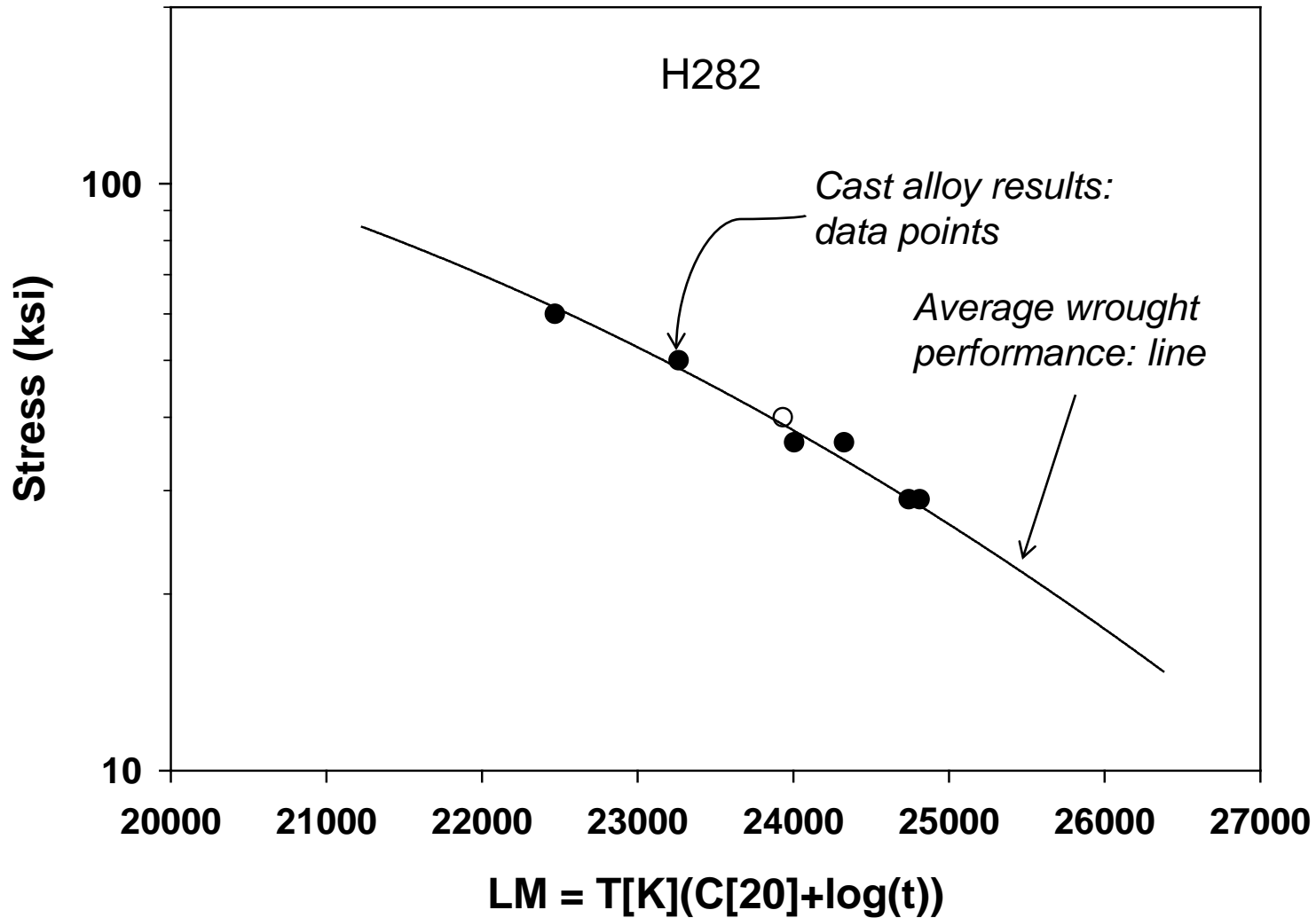

Solid Solution Alloys

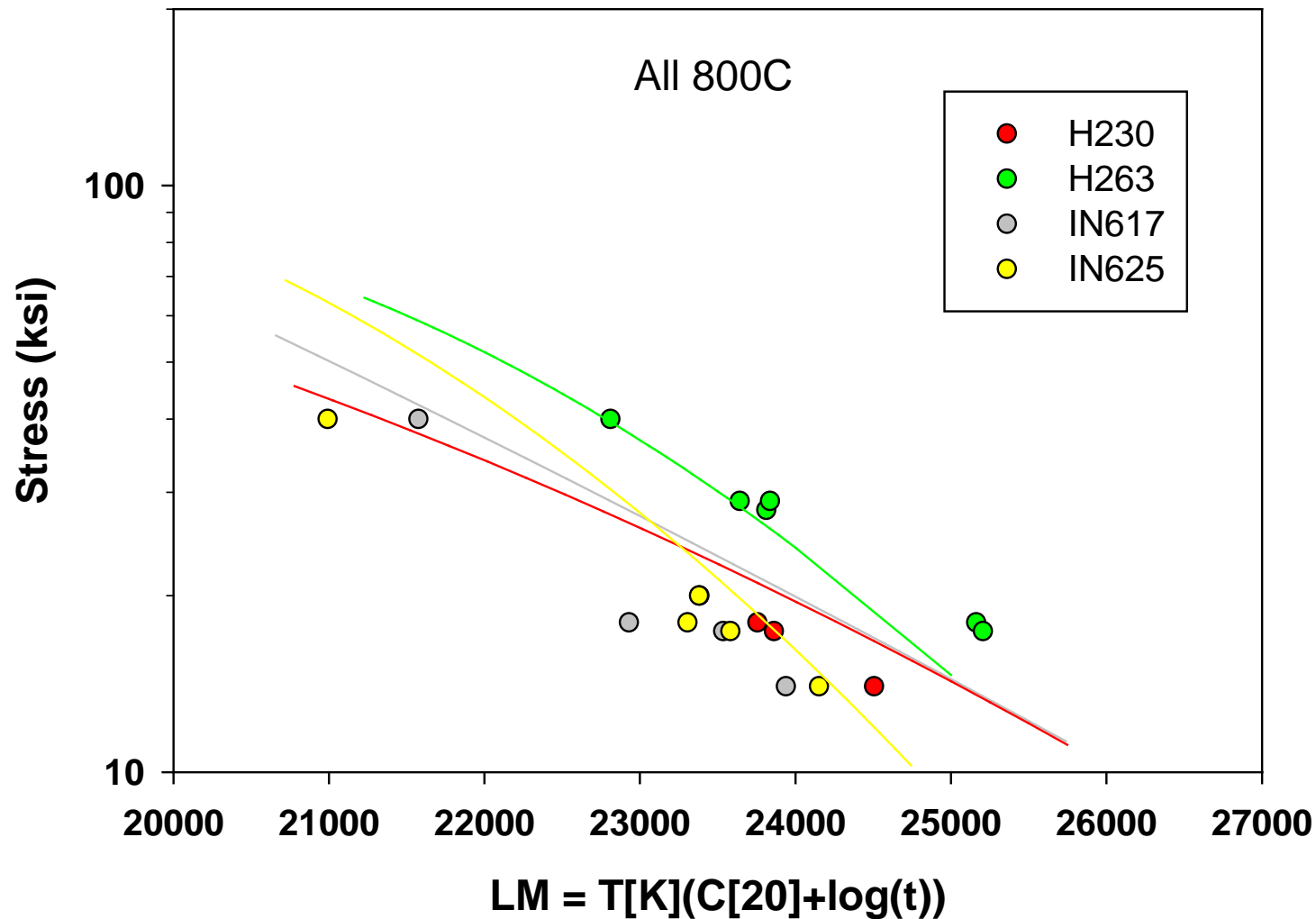

Gamma Prime Formers

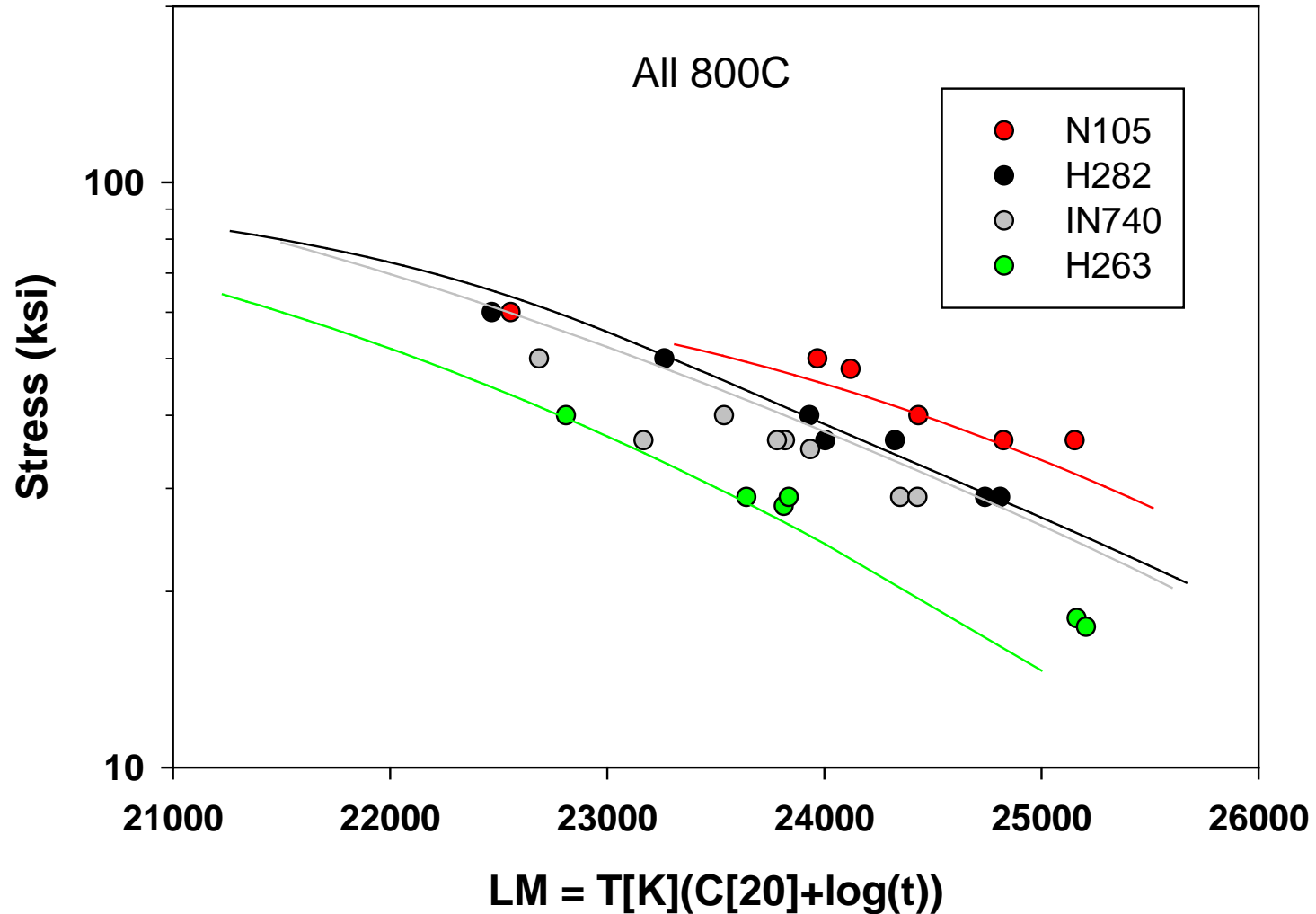

Alloys Under Consideration for Steam Oxidation Resistance

Solid Solution	Age Hardenable
H230	N105
IN617	H263
IN625	H282
	IN740

Isothermal tests in steam using deaerated water

760 and 800 °C

250 hour cycles for 1000 and 2000 total hours

Oxidation Results H263

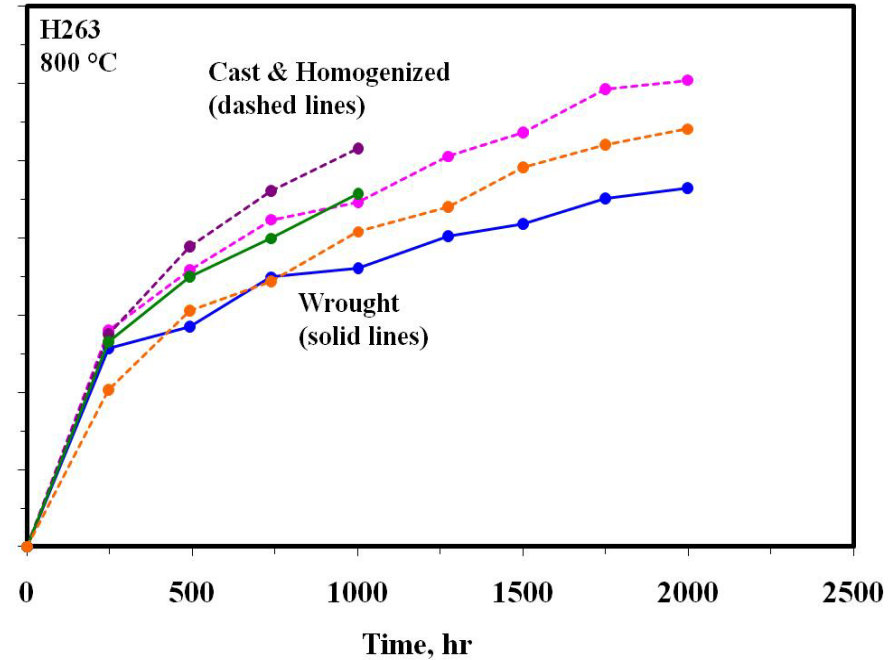
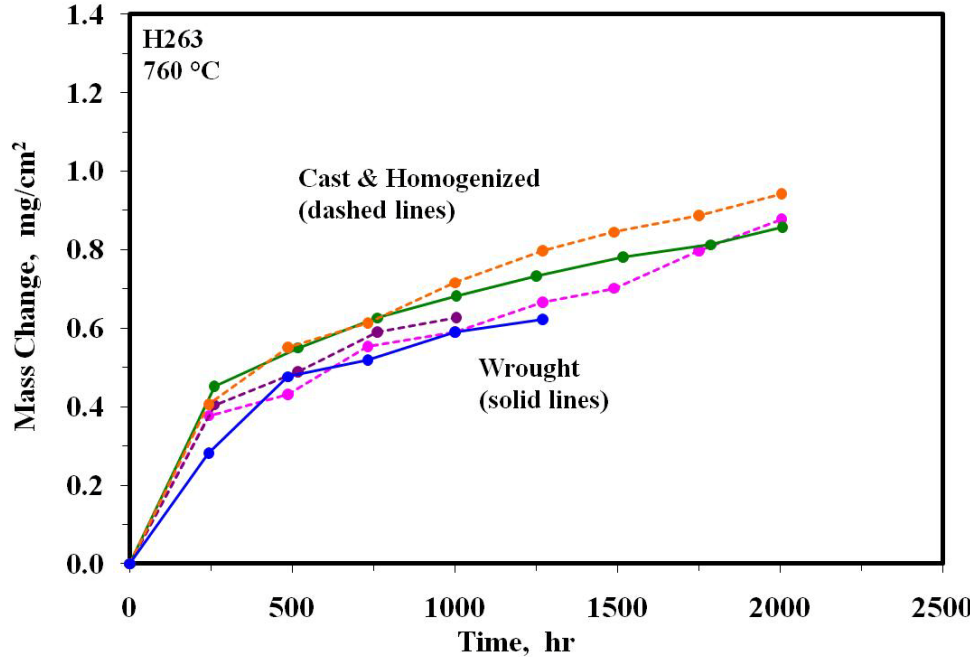

No significant differences between cast & homogenized and wrought

Oxidation Results H282

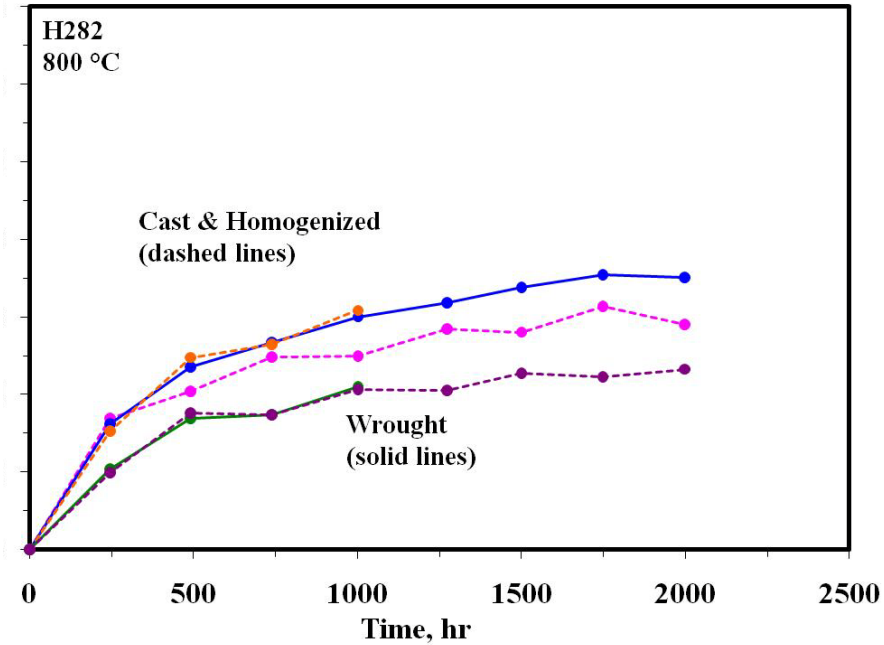
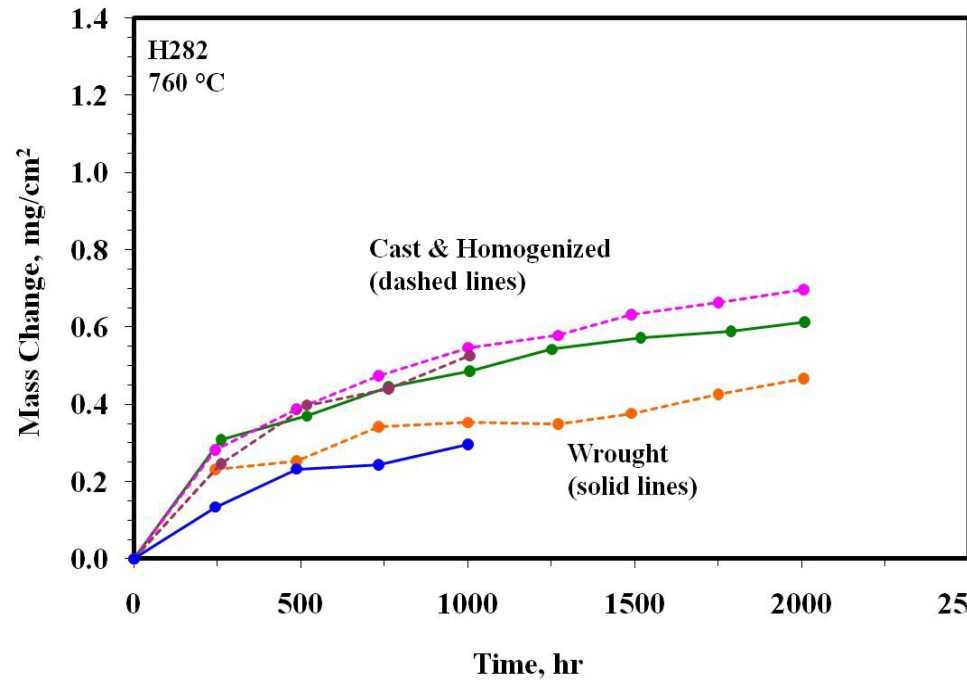

No significant differences between cast & homogenized and wrought

Oxidation Results N105

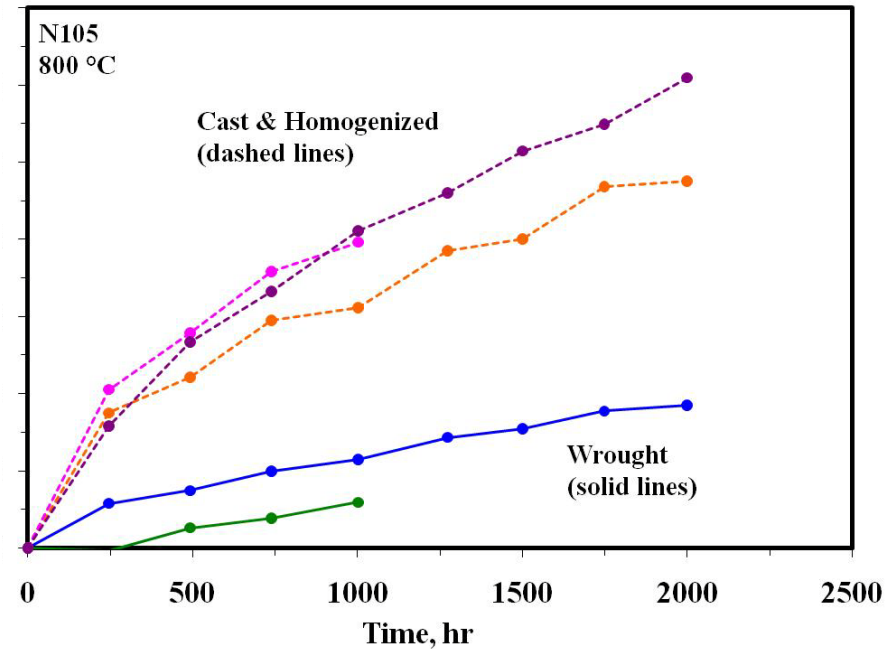
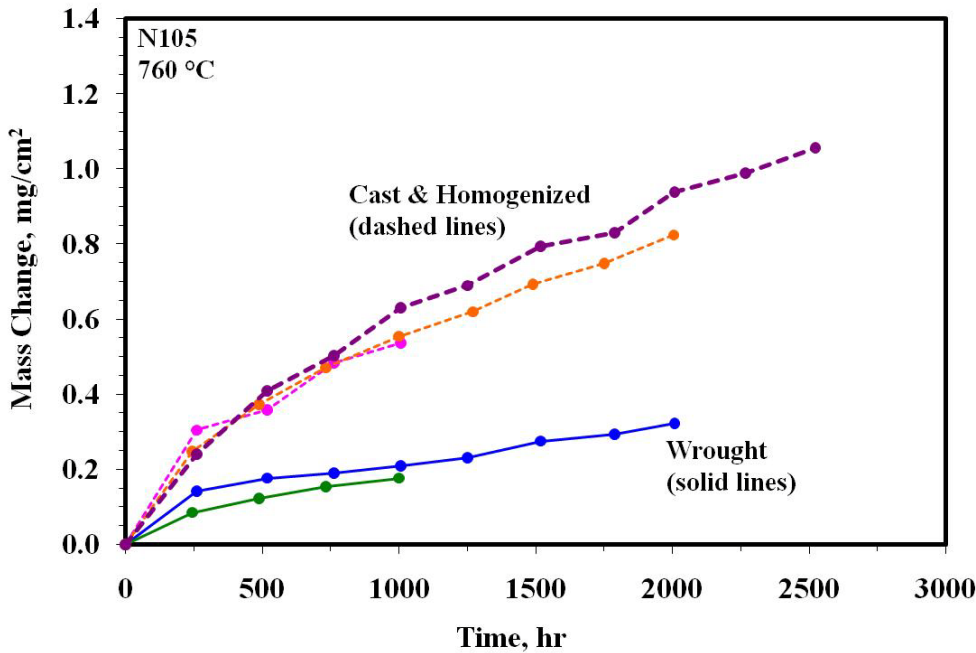

Significant differences between cast & homogenized and wrought

Wrought versions show much less mass gain with time

Exposure in Steam for 1000 hr—H263

Cast and Homogenized

Wrought

760 °C

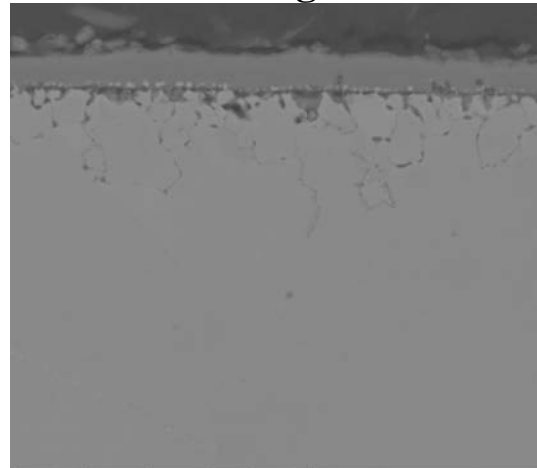
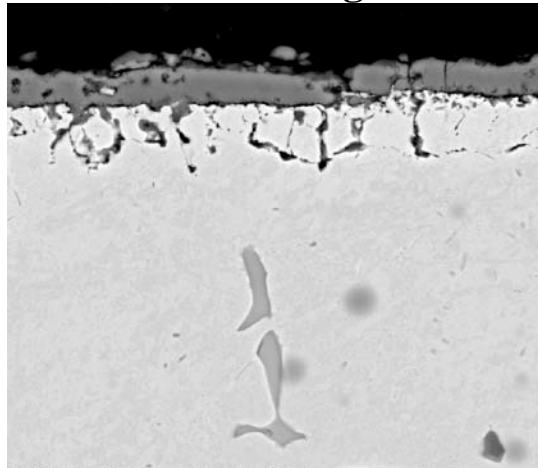

External chromia scales

800 °C

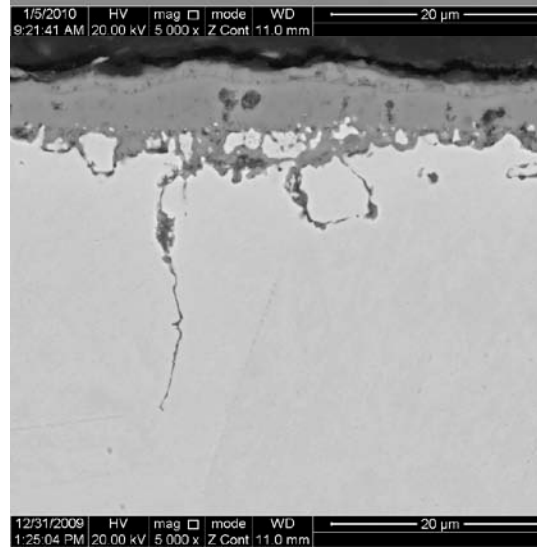
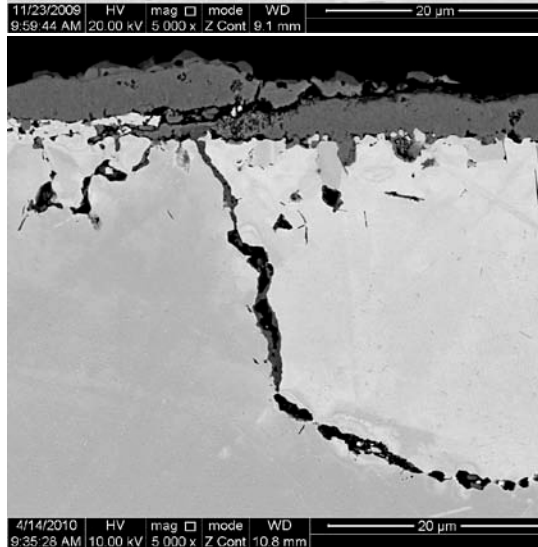

Internal oxidation of Ti and Al was more pronounced in the C&H alloys

Exposure in Steam for 1000 hr—H282

Cast and Homogenized

Wrought

760 °C

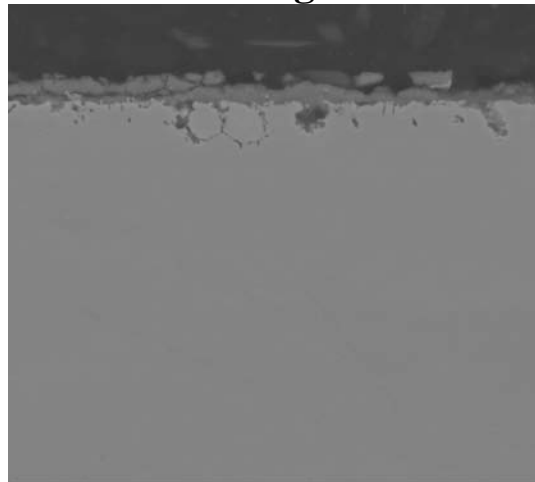
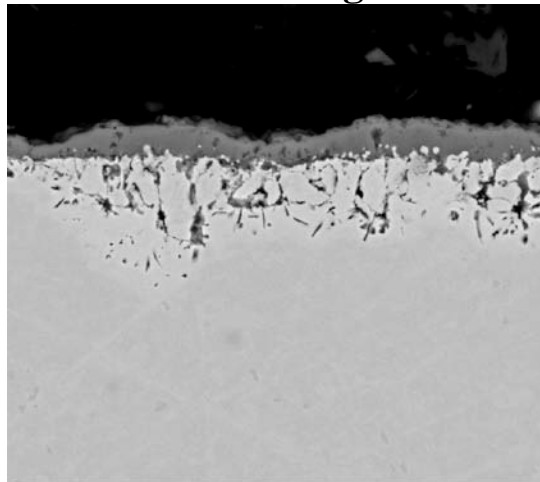

*Over much the same
as in H263*

800 °C

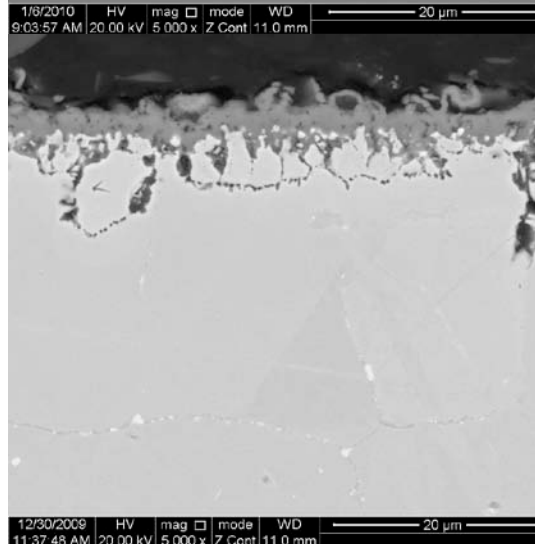
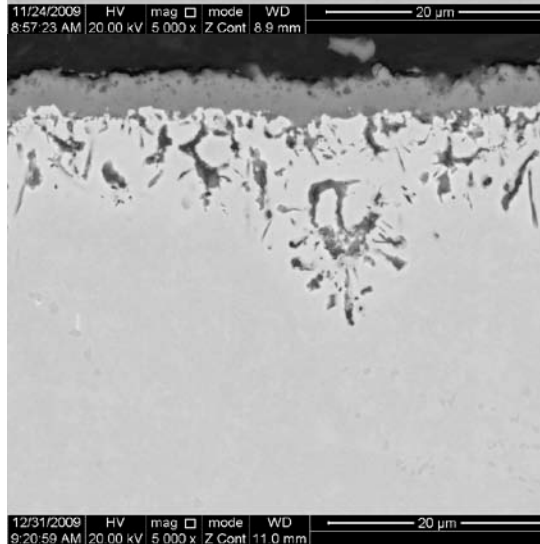

*External chromia
scales*

*Internal oxidation of
Ti and Al was more
pronounced in the
C&H alloys*

Exposure in Steam for 1000 hr—N105

Cast and Homogenized

Wrought

760 °C

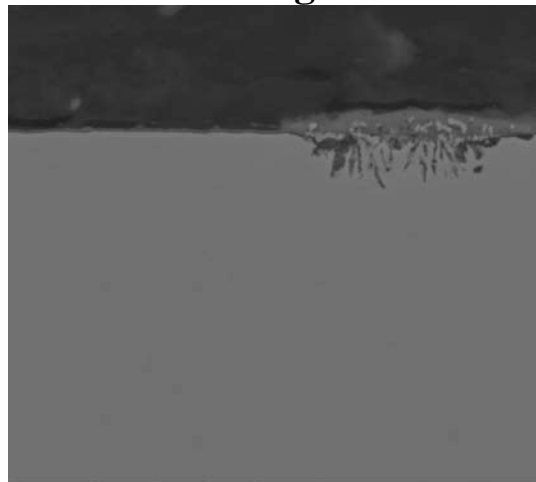
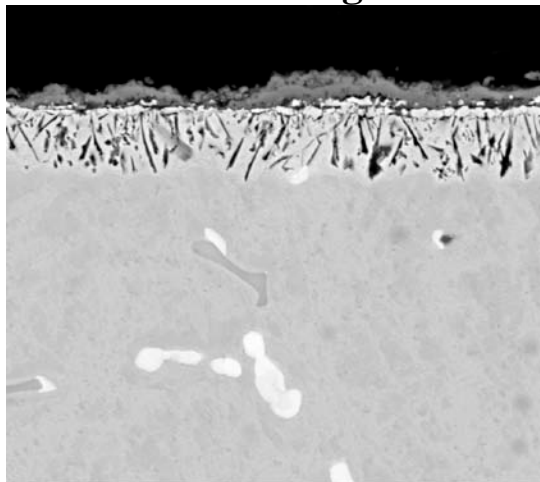

800 °C

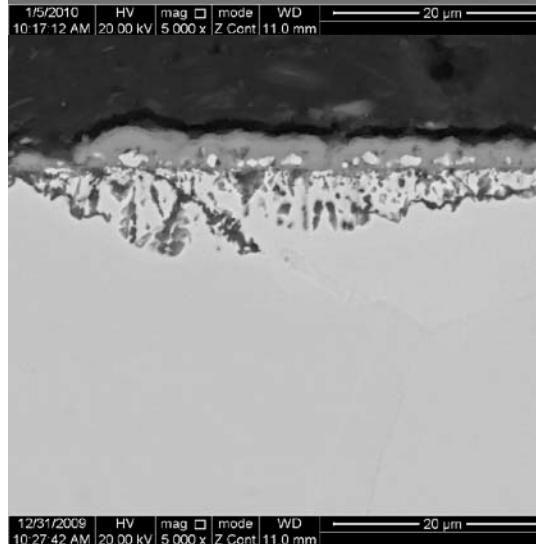
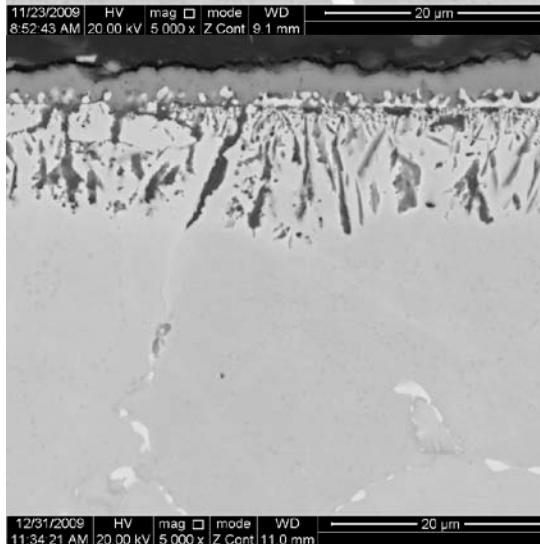

Two types of structures were found

- *Chromia external scale and internal oxidation of Al and Ti*
- *Very thin alumina external scale—found on sections of the wrought alloys at both temperatures*

Alumina scales are much more protective

Scaling Behavior

External Scale and Internal Oxidation Behavior, 760 °C

Alloy		T hr	External Scale		Internal Oxidation		
			Thickness μm	std %	Thickness μm	std %	Maximum μm
H263	C&H	1000	2.81 ± 0.63	22%	4.70 ± 4.08	87%	28.2
		2000	3.34 ± 0.97	29%	9.79 ± 5.35	55%	42.6
	Wrought	1000	2.79 ± 0.37	13%	7.11 ± 3.49	49%	16.4
		2000	4.36 ± 0.64	15%	5.18 ± 2.68	52%	23.9
H282	C&H	1000	2.54 ± 0.43	17%	6.92 ± 3.73	54%	34.2
		2000	4.53 ± 1.36	30%	6.26 ± 4.73	76%	38.0
	Wrought	1000	1.13 ± 0.35	30%	1.81 ± 1.07	59%	10.2
		2000	3.00 ± 0.55	18%	5.09 ± 2.20	43%	25.1
N105	C&H	1000	1.52 ± 0.50	33%	5.95 ± 0.69	12%	9.9
		2000	2.86 ± 0.81	28%	10.09 ± 1.90	19%	17.6
	Wrought	1000	0.39 ± 0.47	119%	0.60 ± 1.22	201%	9.3
		2000	0.98 ± 0.86	89%	2.46 ± 2.75	112%	14.9

H263 & H282—External scaling similar between C&H and Wrought

H263 & H282—Internal scaling more pronounced in C&H

N105 Wrought clearly shows partial alumina coverage

Alumina coverage shrinking with time as shown by scaling kinetics

Wrought N105—Borderline Alumina Protection

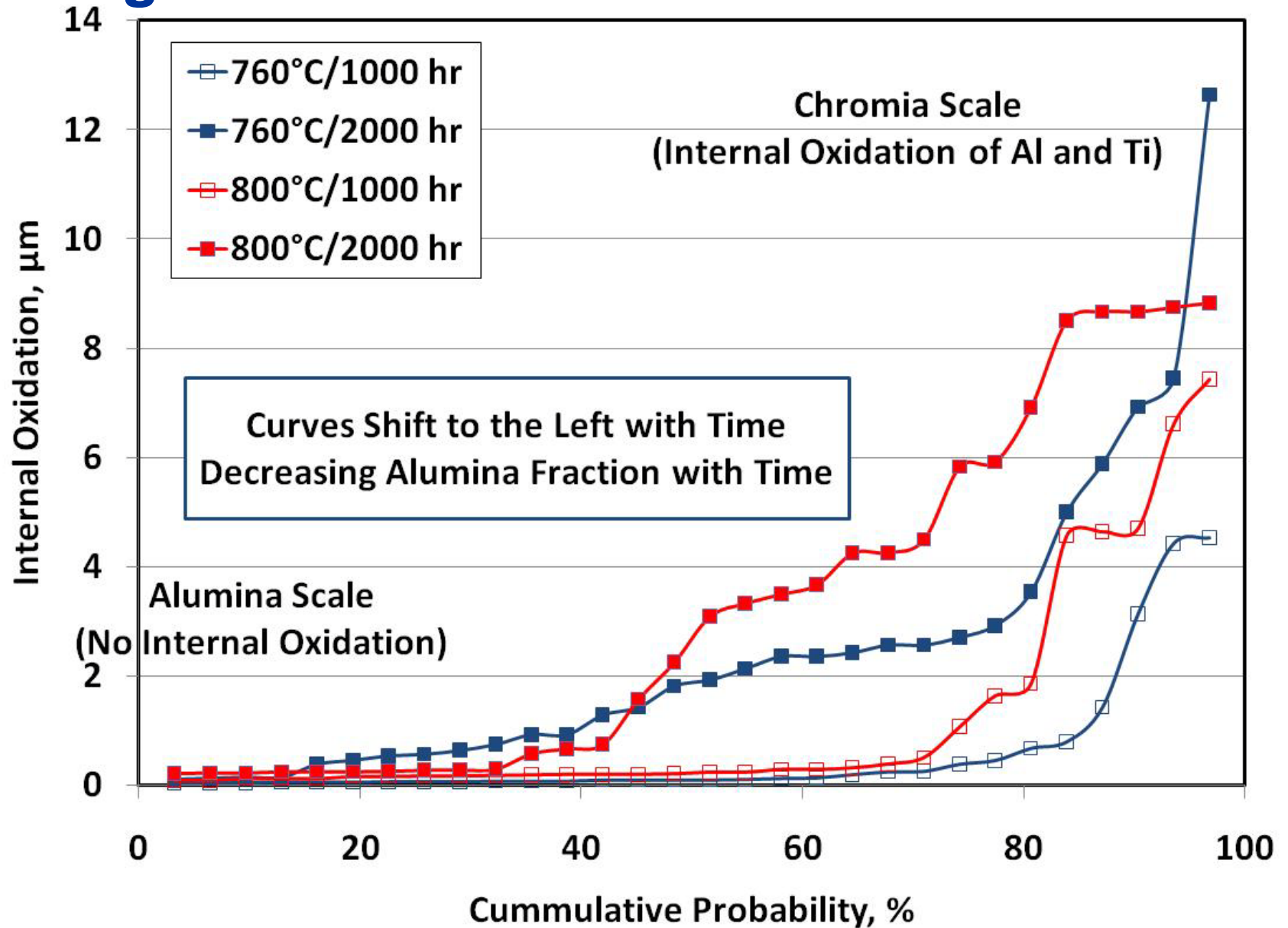

Microstructure after 1000 hr at 800 C—H263

Light precipitates are Mo-rich carbides

Dark precipitates are Cr-rich carbides

More gb precipitate coverage in C&H alloy

Cast and Homogenized

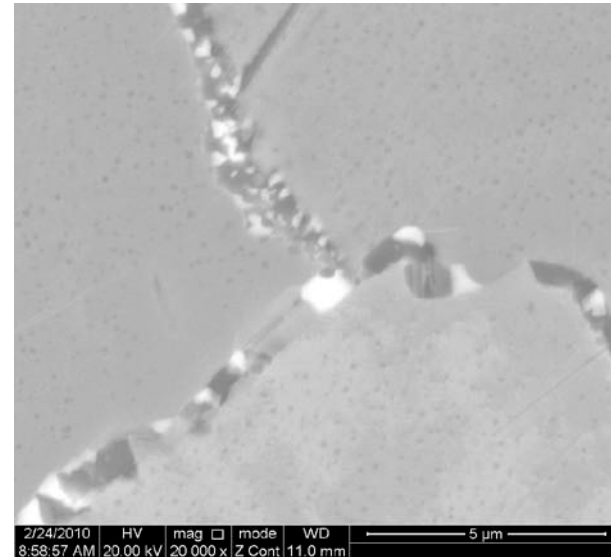

Wrought

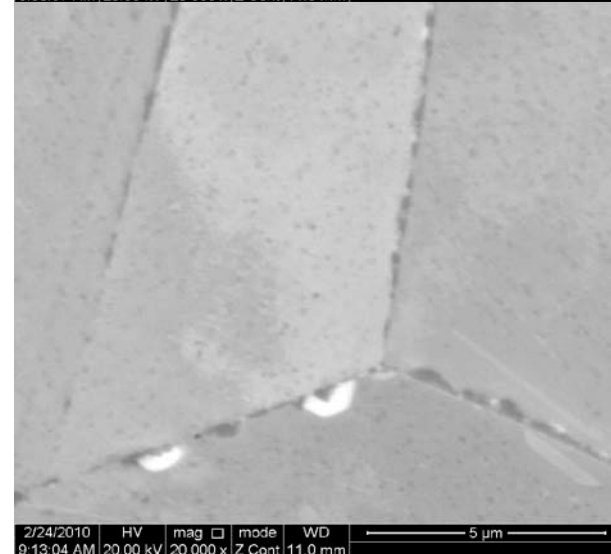

Microstructure after 1000 hr at 800 C—H282

Light precipitates are Mo-rich carbides

Large dark precipitates are Ti-rich carbides

Smaller dark precipitates are Cr-rich carbides

More gb precipitate coverage in C&H alloy

Cast and Homogenized

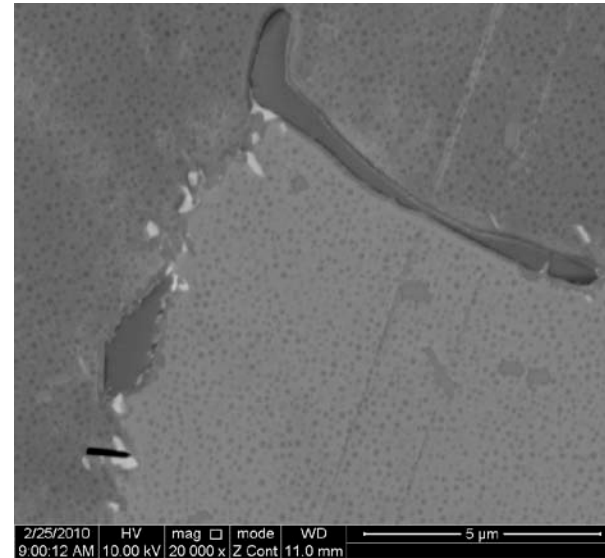

Wrought

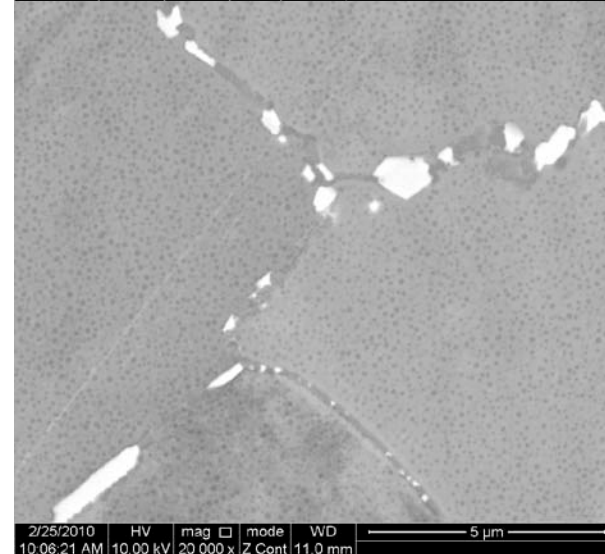

Microstructure after 1000 hr at 800 C—N105

Light precipitates are Mo-rich carbides

Dark precipitates are Ti and Cr-rich carbides in C&H alloy

Dark precipitates are Cr-rich carbides in wrought alloy

More gb precipitate coverage in C&H alloy

Cast and Homogenized

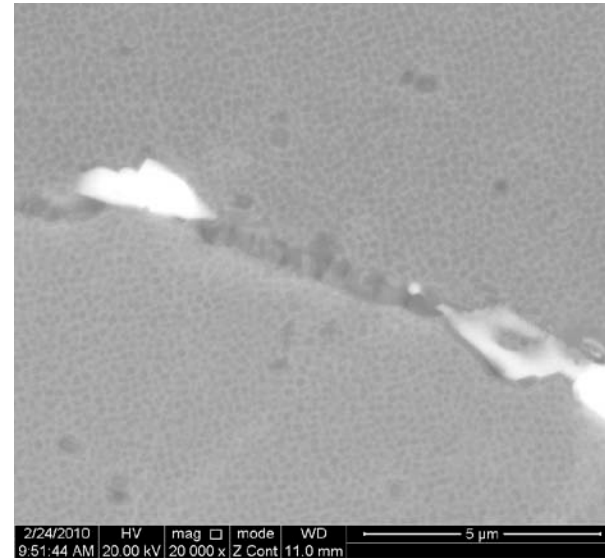

Wrought

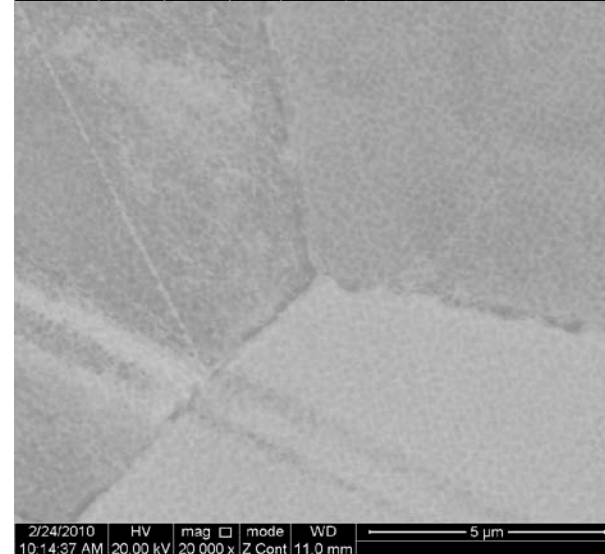

Summary I

The development of high creep strength and steam oxidation resistant cast alloys for use in A-USC steam turbines is required to meet the need of some of the large components that comprise the turbine

A computationally optimized homogenization heat treatment was developed to improve the performance of these materials

H263, H282, and N105, were selected based on good cast-alloy creep resistance for further examination in terms of steam oxidation resistance

Summary II

H263 and H282

- External chromia scale (both C&H and wrought alloys)
- Internal oxidation of Al and Ti (both C&H and wrought alloys)
- The overall mass gain and parabolic kinetics were similar
- The depth of internal oxidation was greater in the C&H alloys
- More Mo-rich and Cr-rich carbides were found at gbs of the C&H alloys
- Ti-rich carbides were found along gbs of the C&H H282 alloys

N105

- Wrought alloys exhibited lower oxidation kinetics than the C&H alloys
- Some of the surface of the wrought alloys was covered by a very protective alumina scale
- Where alumina was not present, a chromia scale was present with internal oxidation of Al and Ti
- Fraction of the surface protected by the alumina scale decreased with time
- C&H gbs contained Mo-rich carbides, Ti-rich carbides, and Cr-rich carbides
- Only Cr-rich carbides on the wrought N105 gbs